

Bias Resistor Transistors

PNP Silicon Surface Mount Transistors with Monolithic Bias Resistor Network

This new series of digital transistors is designed to replace a single device and its external resistor bias network. The BRT (Bias Resistor Transistor) contains a single transistor with a monolithic bias network consisting of two resistors; a series base resistor and a base-emitter resistor. The BRT eliminates these individual components by integrating them into a single device. The use of a BRT can reduce both system cost and board space. The device is housed in the SOT-23 package which is designed for low power surface mount applications.

- Simplifies Circuit Design
- Reduces Board Space
- Reduces Component Count
- The SOT-23 package can be soldered using wave or reflow. The modified gull-winged leads absorb thermal stress during soldering eliminating the possibility of damage to the die.
- Available in 8 mm embossed tape and reel. Use the Device Number to order the 7 inch/3000 unit reel. Replace “T1” with “T3” in the Device Number to order the 13 inch/10,000 unit reel.
- We declare that the material of product compliance with RoHS requirements.

LMUN2111LT1G SERIES

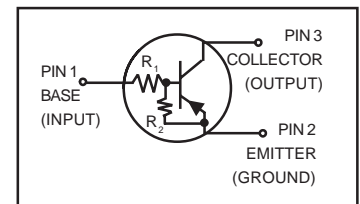

MAXIMUM RATINGS ($T_A = 25^\circ\text{C}$ unless otherwise noted)

Rating	Symbol	Value	Unit
Collector-Base Voltage	V_{CBO}	50	Vdc
Collector-Emitter Voltage	V_{CEO}	50	Vdc
Collector Current	I_C	100	mAdc

THERMAL CHARACTERISTICS

Characteristic	Symbol	Max	Unit
Total Device Dissipation $T_A = 25^\circ\text{C}$ Derate above 25°C	P_D	246 (Note 1.) 400 (Note 2.) 1.5 (Note 1.) 2.0 (Note 2.)	mW $^\circ\text{C/W}$
Thermal Resistance – Junction-to-Ambient	$R_{\theta JA}$	508 (Note 1.) 311 (Note 2.)	$^\circ\text{C/W}$
Thermal Resistance – Junction-to-Lead	$R_{\theta JL}$	174 (Note 1.) 208 (Note 2.)	$^\circ\text{C/W}$
Junction and Storage Temperature Range	T_J, T_{stg}	-55 to +150	$^\circ\text{C}$

1. FR-4 @ Minimum Pad
2. FR-4 @ 1.0 x 1.0 inch Pad

LMUN2111LT1G Series

DEVICE MARKING AND RESISTOR VALUES

Device	Package	Marking	R1 (K)	R2 (K)	Shipping
LMUN2110LT1G LMUN2110LT3G	SOT-23	A6O	47	∞	3000/Tape & Reel 10,000/Tape & Reel
LMUN2111LT1G LMUN2111LT3G	SOT-23	A6A	10	10	3000/Tape & Reel 10,000/Tape & Reel
LMUN2112LT1G LMUN2112LT3G	SOT-23	A6B	22	22	3000/Tape & Reel 10,000/Tape & Reel
LMUN2113LT1G LMUN2113LT3G	SOT-23	A6C	47	47	3000/Tape & Reel 10,000/Tape & Reel
LMUN2114LT1G LMUN2114LT3G	SOT-23	A6D	10	47	3000/Tape & Reel 10,000/Tape & Reel
LMUN2115LT1G (Note 3.) LMUN2115LT3G	SOT-23	A6E	10	∞	3000/Tape & Reel 10,000/Tape & Reel
LMUN2116LT1G (Note 3.) LMUN2116LT3G	SOT-23	A6F	4.7	∞	3000/Tape & Reel 10,000/Tape & Reel
LMUN2130LT1G (Note 3.) LMUN2130LT3G	SOT-23	A6G	1.0	1.0	3000/Tape & Reel 10,000/Tape & Reel
LMUN2131LT1G (Note 3.) LMUN2131LT3G	SOT-23	A6H	2.2	2.2	3000/Tape & Reel 10,000/Tape & Reel
LMUN2132LT1G (Note 3.) LMUN2132LT3G	SOT-23	A6J	4.7	4.7	3000/Tape & Reel 10,000/Tape & Reel
LMUN2133LT1G (Note 3.) LMUN2133LT3G	SOT-23	A6K	4.7	47	3000/Tape & Reel 10,000/Tape & Reel
LMUN2134LT1G (Note 3.) LMUN2134LT3G	SOT-23	A6L	22	47	3000/Tape & Reel 10,000/Tape & Reel

ELECTRICAL CHARACTERISTICS ($T_A = 25^\circ\text{C}$ unless otherwise noted)

Characteristic	Symbol	Min	Typ	Max	Unit
----------------	--------	-----	-----	-----	------

OFF CHARACTERISTICS

Collector-Base Cutoff Current ($V_{CB} = 50\text{ V}, I_E = 0$)	I_{CBO}	–	–	100	nAdc
Collector-Emitter Cutoff Current ($V_{CE} = 50\text{ V}, I_B = 0$)	I_{CEO}	–	–	500	nAdc
Emitter-Base Cutoff Current ($V_{EB} = 6.0\text{ V}, I_C = 0$)	I_{EBO}	–	–	0.1	mAdc
LMUN2110LT1G		–	–	0.5	
LMUN2111LT1G		–	–	0.2	
LMUN2112LT1G		–	–	0.1	
LMUN2113LT1G		–	–	0.2	
LMUN2114LT1G		–	–	0.9	
LMUN2115LT1G		–	–	1.9	
LMUN2130LT1G		–	–	4.3	
LMUN2131LT1G		–	–	2.3	
LMUN2132LT1G		–	–	1.5	
LMUN2133LT1G		–	–	0.18	
LMUN2134LT1G		–	–	0.13	
Collector-Base Breakdown Voltage ($I_C = 10\ \mu\text{A}, I_E = 0$)	$V_{(BR)CBO}$	50	–	–	Vdc
Collector-Emitter Breakdown Voltage (Note 4.) ($I_C = 2.0\text{ mA}, I_B = 0$)	$V_{(BR)CEO}$	50	–	–	Vdc

3. New devices. Updated curves to follow in subsequent data sheets.
4. Pulse Test: Pulse Width < 300 μs , Duty Cycle < 2.0%

LMUN2111LT1G Series

ELECTRICAL CHARACTERISTICS ($T_A = 25^\circ\text{C}$ unless otherwise noted) (Continued)

Characteristic	Symbol	Min	Typ	Max	Unit	
ON CHARACTERISTICS (Note 5.)						
DC Current Gain ($V_{CE} = 10\text{ V}$, $I_C = 5.0\text{ mA}$)	LMUN2110LT1G LMUN2111LT1G LMUN2112LT1G LMUN2113LT1G LMUN2114LT1G LMUN2115LT1G LMUN2116LT1G LMUN2130LT1G LMUN2131LT1G LMUN2132LT1G LMUN2133LT1G LMUN2134LT1G	h_{FE}	80 35 60 80 80 160 160 3.0 8.0 15 80 80	140 60 100 140 140 250 250 5.0 15 27 140 130	– – – – – – – – – – – –	
Collector-Emitter Saturation Voltage ($I_C = 10\text{ mA}$, $I_B = 0.3\text{ mA}$) ($I_C = 10\text{ mA}$, $I_B = 5\text{ mA}$) LMUN2130LT1G/LMUN2131LT1G ($I_C = 10\text{ mA}$, $I_B = 1\text{ mA}$) LMUN2115LT1G/LMUN2116LT1G/ LMUN2132LT1G/LMUN2133LT1G/LMUN2134LT1G		$V_{CE(sat)}$	–	–	0.25	Vdc
Output Voltage (on) ($V_{CC} = 5.0\text{ V}$, $V_B = 2.5\text{ V}$, $R_L = 1.0\text{ k}\Omega$) ($V_{CC} = 5.0\text{ V}$, $V_B = 3.5\text{ V}$, $R_L = 1.0\text{ k}\Omega$)	LMUN2110LT1G LMUN2114LT1G LMUN2111LT1G LMUN2112LT1G LMUN2114LT1G LMUN2115LT1G LMUN2116LT1G LMUN2130LT1G LMUN2131LT1G LMUN2132LT1G LMUN2133LT1G LMUN2134LT1G LMUN2113LT1G	V_{OL}	– – – – – – – – – – – – – –	– – – – – – – – – – – – – –	0.2 0.2 0.2 0.2 0.2 0.2 0.2 0.2 0.2 0.2 0.2 0.2 0.2 0.2	Vdc
Output Voltage (off) ($V_{CC} = 5.0\text{ V}$, $V_B = 0.5\text{ V}$, $R_L = 1.0\text{ k}\Omega$) ($V_{CC} = 5.0\text{ V}$, $V_B = 0.25\text{ V}$, $R_L = 1.0\text{ k}\Omega$) ($V_{CC} = 5.0\text{ V}$, $V_B = 0.050\text{ V}$, $R_L = 1.0\text{ k}\Omega$)	LMUN2115LT1G LMUN2116LT1G LMUN2131LT1G LMUN2132LT1G LMUN2130LT1G	V_{OH}	4.9	–	–	Vdc
Input Resistor	LMUN2110LT1G LMUN2111LT1G LMUN2112LT1G LMUN2113LT1G LMUN2114LT1G LMUN2115LT1G LMUN2116LT1G LMUN2130LT1G LMUN2131LT1G LMUN2132LT1G LMUN2133LT1G LMUN2134LT1G	R_1	32.9 7.0 15.4 32.9 7.0 7.0 3.3 0.7 1.5 3.3 3.3 15.4	47 10 22 47 10 10 4.7 1.0 2.2 4.7 4.7 22	61.1 13 28.6 61.1 13 13 6.1 1.3 2.9 6.1 6.1 28.6	k Ω
Resistor Ratio	LMUN2111LT1G/LMUN2112LT1G/LMUN2113LT1G LMUN2114LT1G LMUN2115LT1G/LMUN2116LT1G/LMUN2110LT1G LMUN2130LT1G/LMUN2131LT1G/LMUN2132LT1G LMUN2133LT1G	R_1/R_2	0.8 0.17 – 0.8 0.055	1.0 0.21 – 1.0 0.1	1.2 0.25 – 1.2 0.185	

5. Pulse Test: Pulse Width < 300 μs , Duty Cycle < 2.0%

LMUN2111LT1G Series

TYPICAL ELECTRICAL CHARACTERISTICS
LMUN2111LT1G

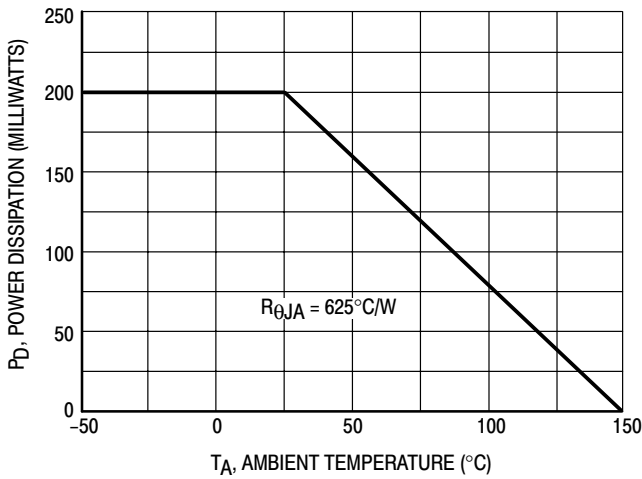

Figure 1. Derating Curve

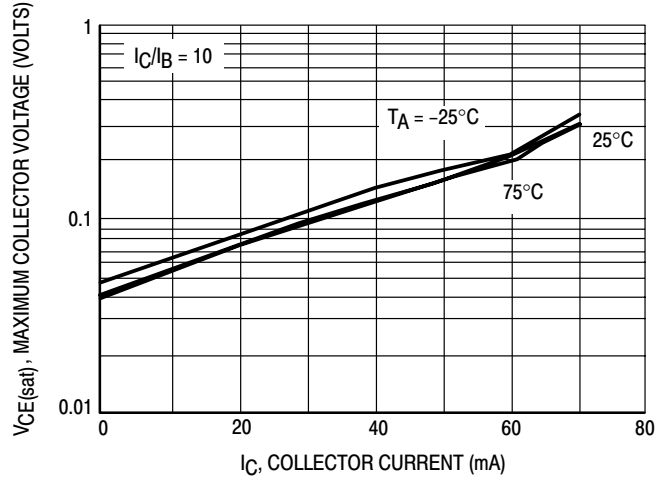

Figure 2. $V_{CE(sat)}$ versus I_C



Figure 3. DC Current Gain

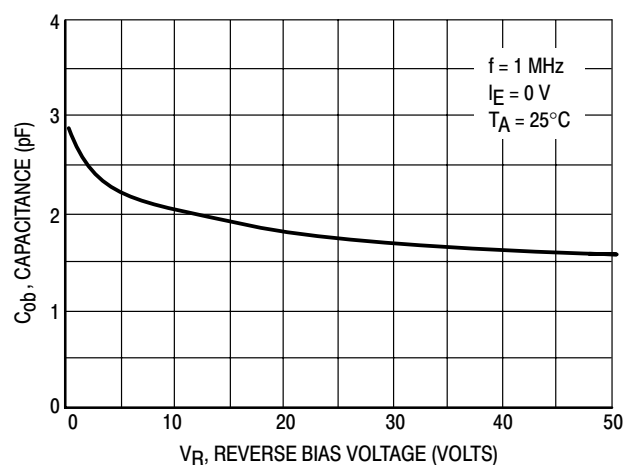

Figure 4. Output Capacitance

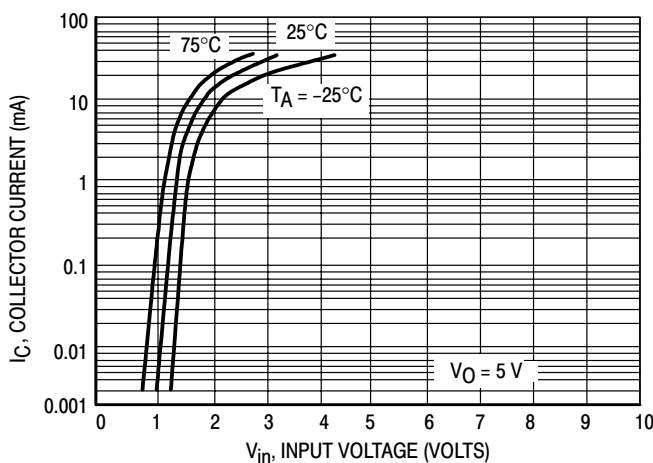

Figure 5. Output Current versus Input Voltage

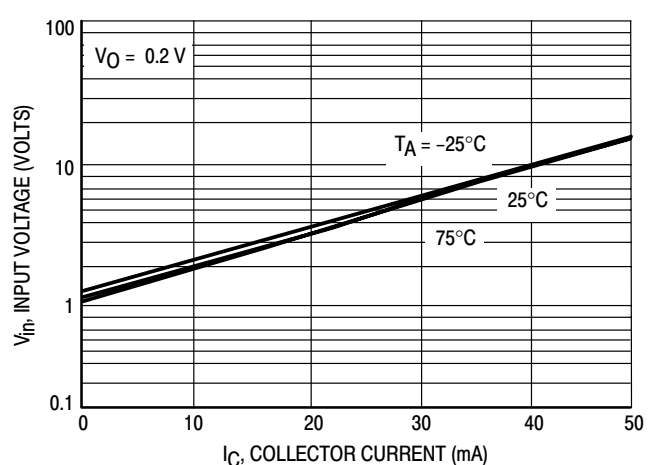

Figure 6. Input Voltage versus Output Current

LMUN2111LT1G Series

TYPICAL ELECTRICAL CHARACTERISTICS
LMUN2112LT1G

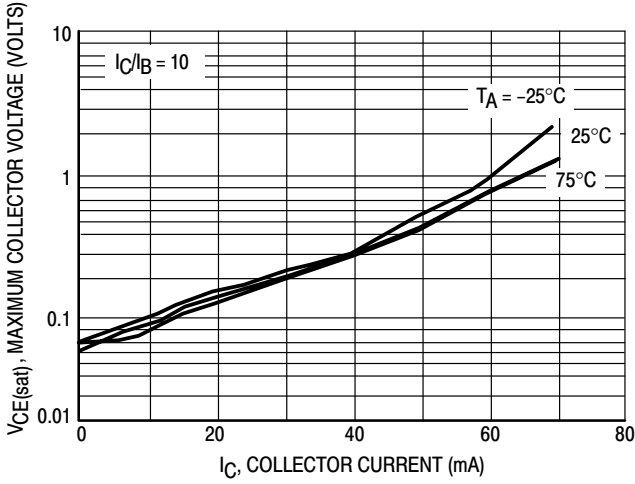

Figure 7. $V_{CE(sat)}$ versus I_C

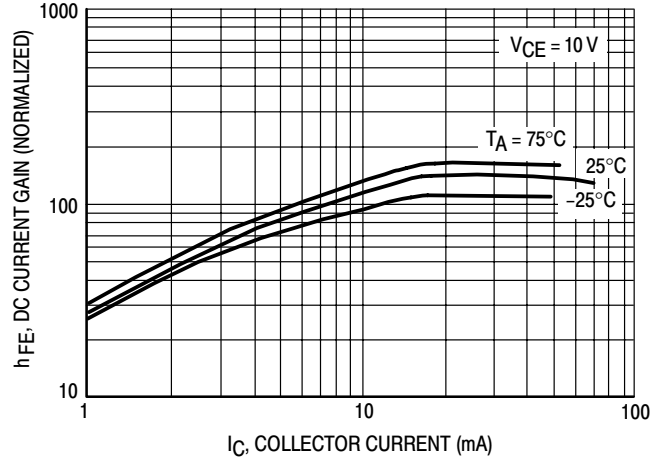

Figure 8. DC Current Gain

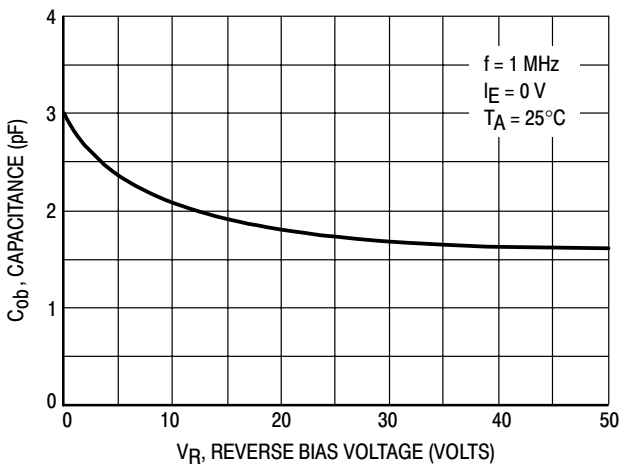

Figure 9. Output Capacitance

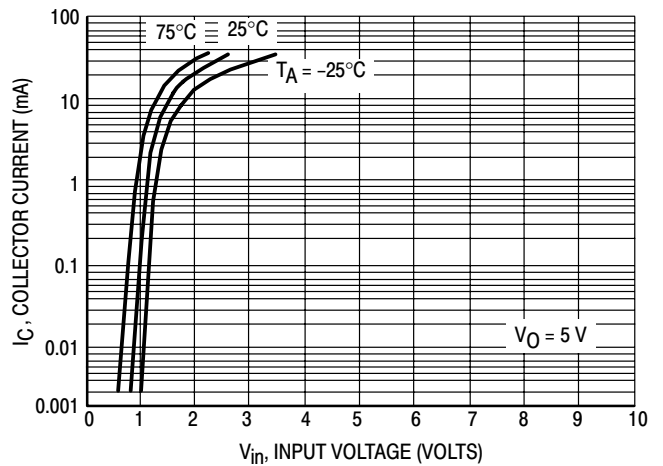

Figure 10. Output Current versus Input Voltage



Figure 11. Input Voltage versus Output Current

LMUN2111LT1G Series

TYPICAL ELECTRICAL CHARACTERISTICS
LMUN2113LT1G

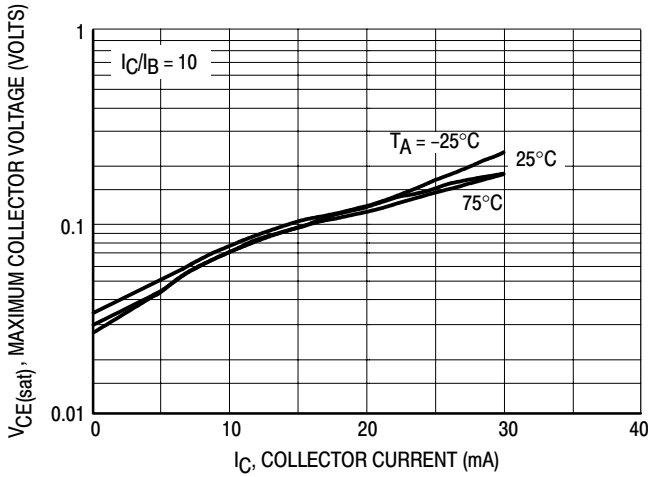

Figure 12. $V_{CE(sat)}$ versus I_C

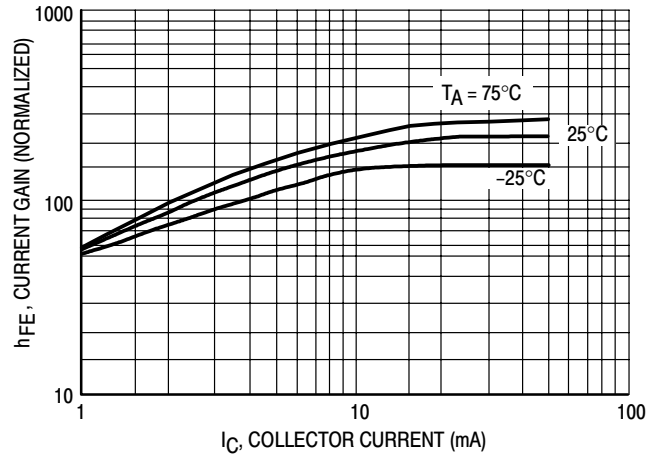

Figure 13. DC Current Gain

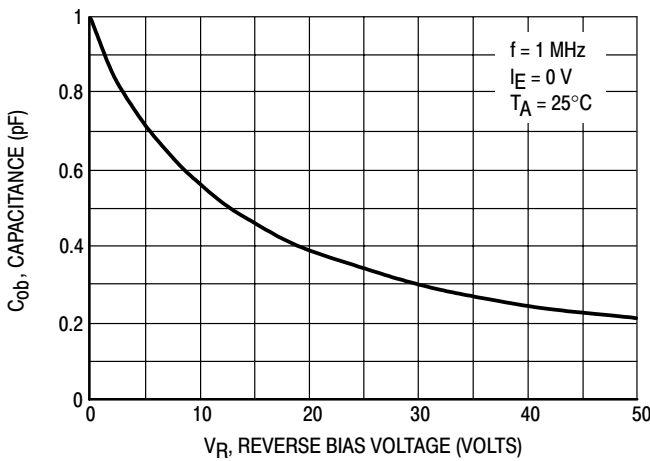

Figure 14. Output Capacitance

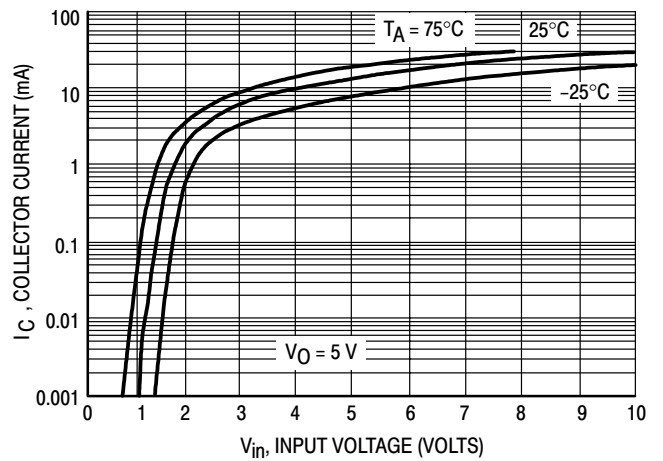

Figure 15. Output Current versus Input Voltage



Figure 16. Input Voltage versus Output Current

LMUN2111LT1G Series

TYPICAL ELECTRICAL CHARACTERISTICS
LMUN2114LT1G



Figure 17. $V_{CE(sat)}$ versus I_C



Figure 18. DC Current Gain

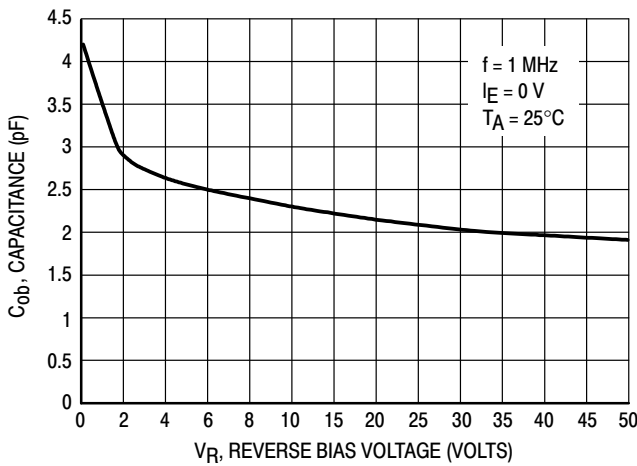

Figure 19. Output Capacitance

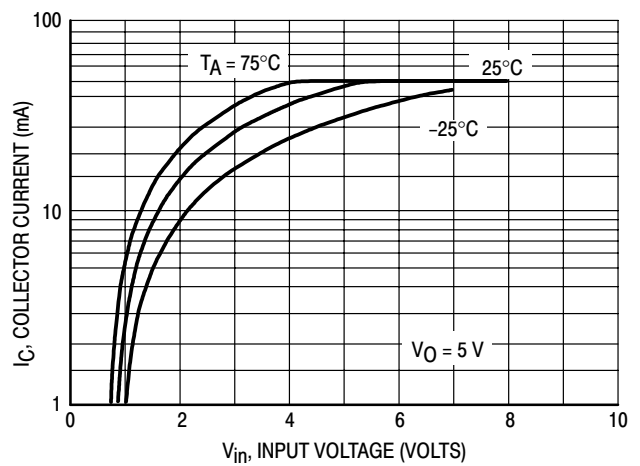

Figure 20. Output Current versus Input Voltage

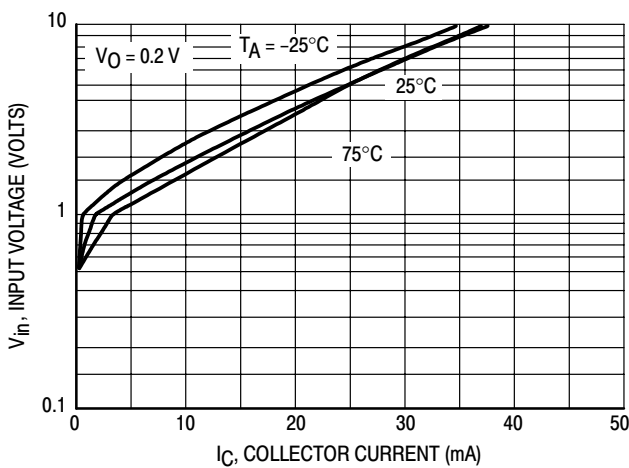

Figure 21. Input Voltage versus Output Current

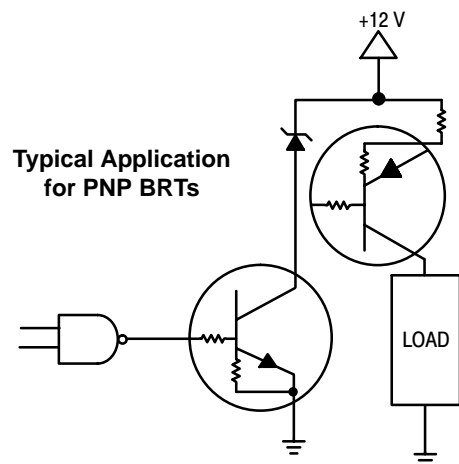
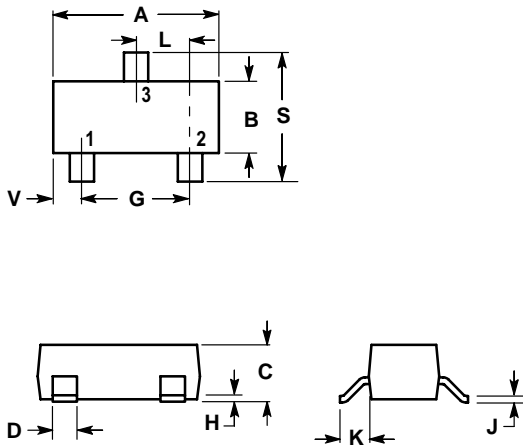

Figure 22. Inexpensive, Unregulated Current Source

LMUN2111LT1G Series

SOT-23



NOTES:

1. DIMENSIONING AND TOLERANCING PER ANSI Y14.5M, 1982.
2. CONTROLLING DIMENSION: INCH.

DIM	INCHES		MILLIMETERS	
	MIN	MAX	MIN	MAX
A	0.1102	0.1197	2.80	3.04
B	0.0472	0.0551	1.20	1.40
C	0.0350	0.0440	0.89	1.11
D	0.0150	0.0200	0.37	0.50
G	0.0701	0.0807	1.78	2.04
H	0.0005	0.0040	0.013	0.100
J	0.0034	0.0070	0.085	0.177
K	0.0140	0.0285	0.35	0.69
L	0.0350	0.0401	0.89	1.02
S	0.0830	0.1039	2.10	2.64
V	0.0177	0.0236	0.45	0.60

- PIN 1. BASE
 2. EMITTER
 3. COLLECTOR

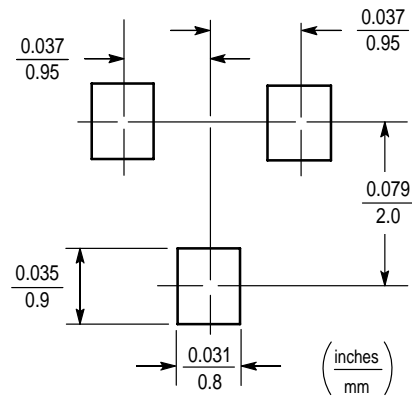

EMBOSSED TAPE AND REEL DATA FOR DISCRETES

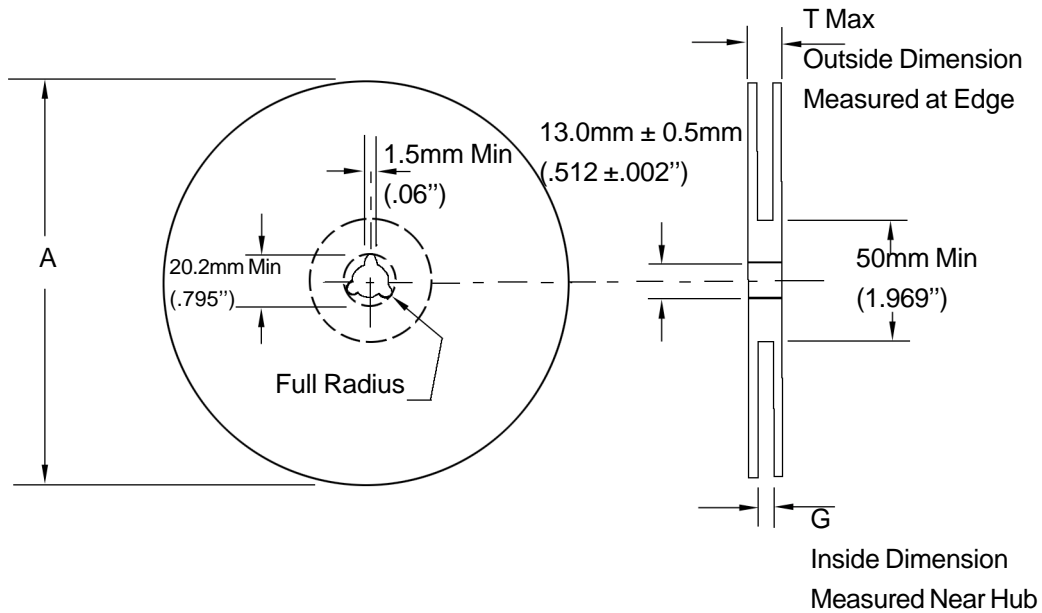

Size	A Max	G	T Max
8 mm	330mm (12.992")	8.4mm+1.5mm, -0.0 (.33"+.059", -0.00)	14.4mm (.56")

Reel Dimensions

Metric Dimensions Govern — English are in parentheses for reference only

Storage Conditions

Temperature: 5 to 40 Deg.C (20 to 30 Deg. C is preferred)

Humidity: 30 to 80 RH (40 to 60 is preferred)

Recommended Period: One year after manufacturing

(This recommended period is for the soldering condition only. The characteristics and reliabilities of the products are not restricted to this limitation)

Shipment Specification

